

Types of Casting

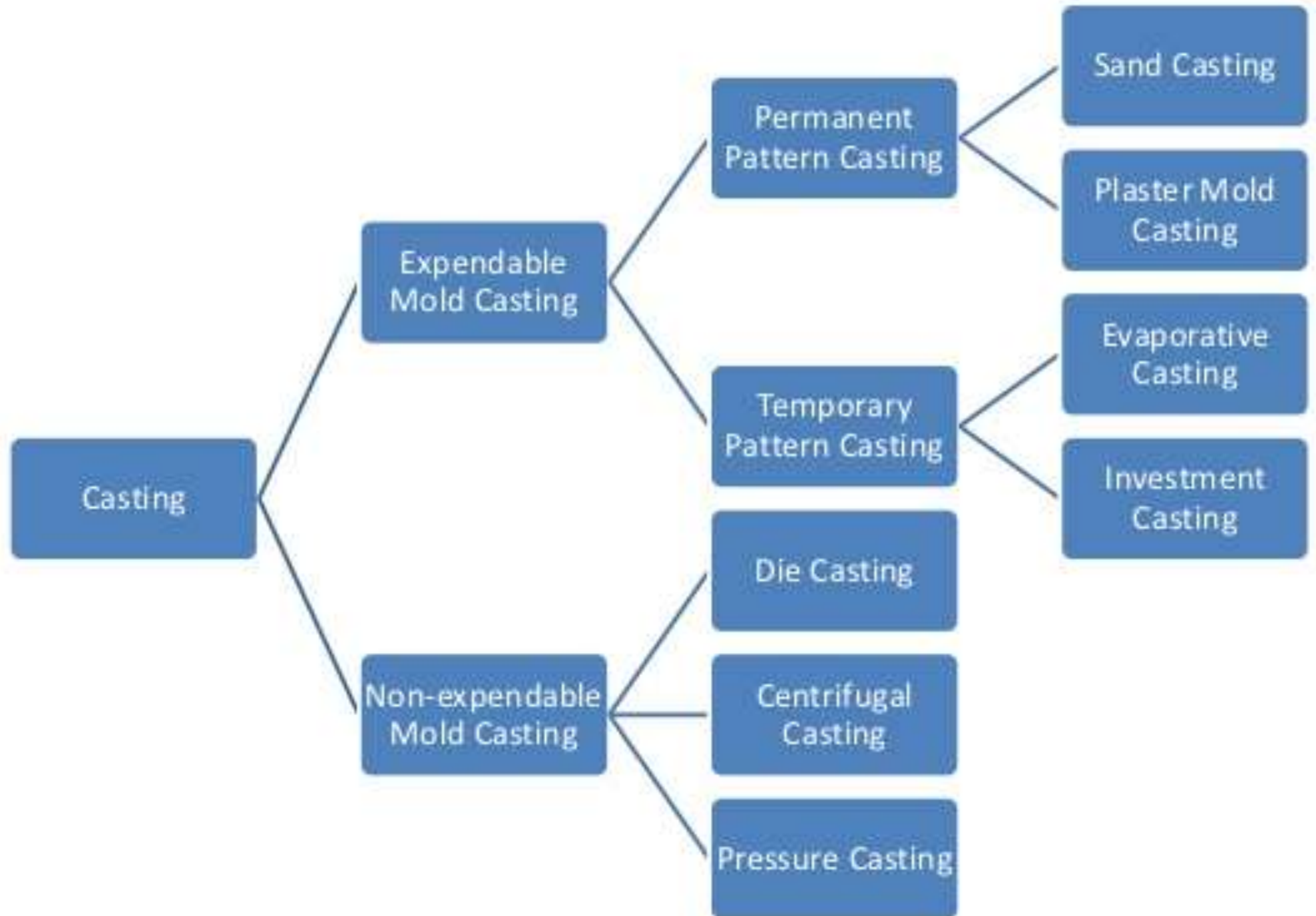

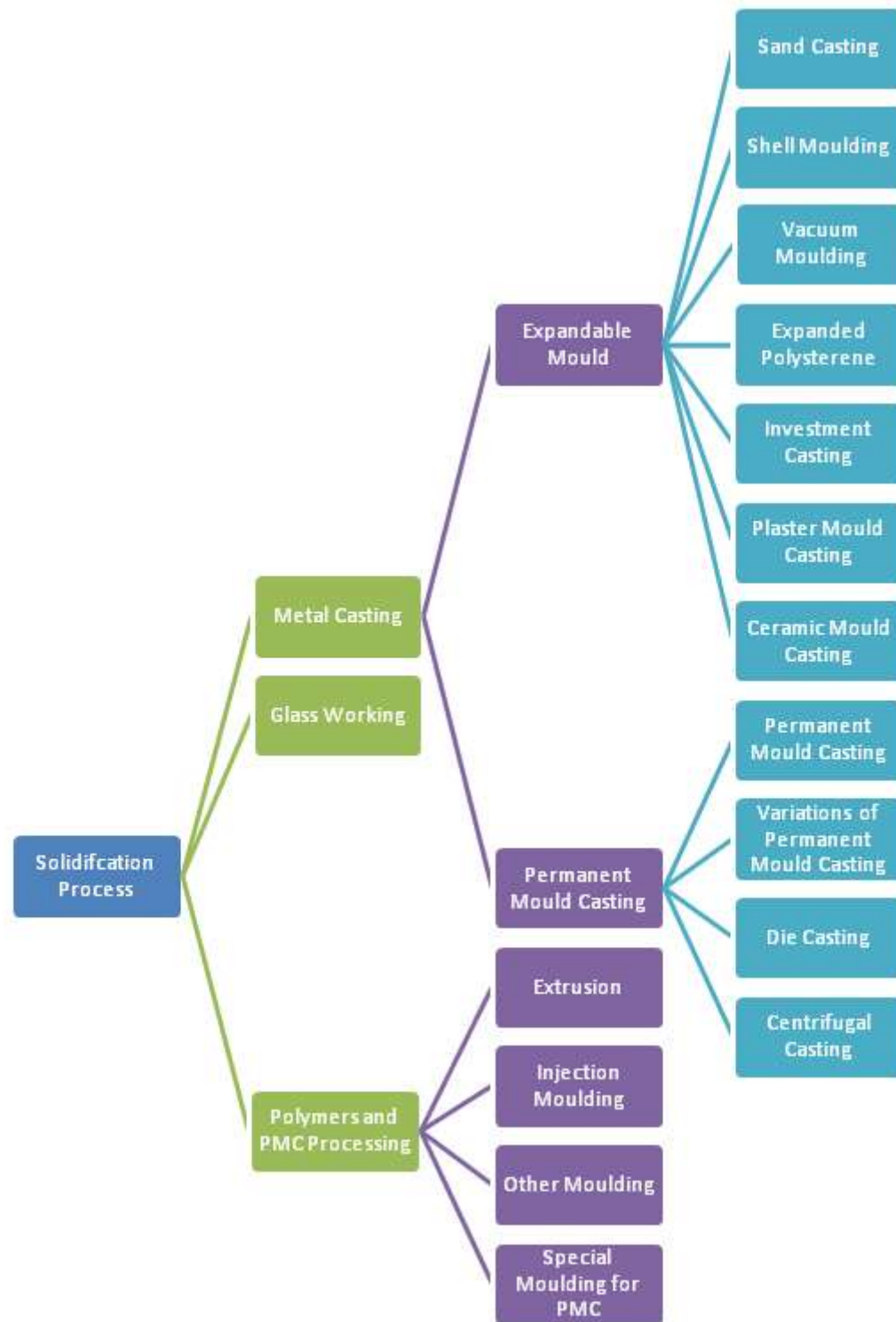

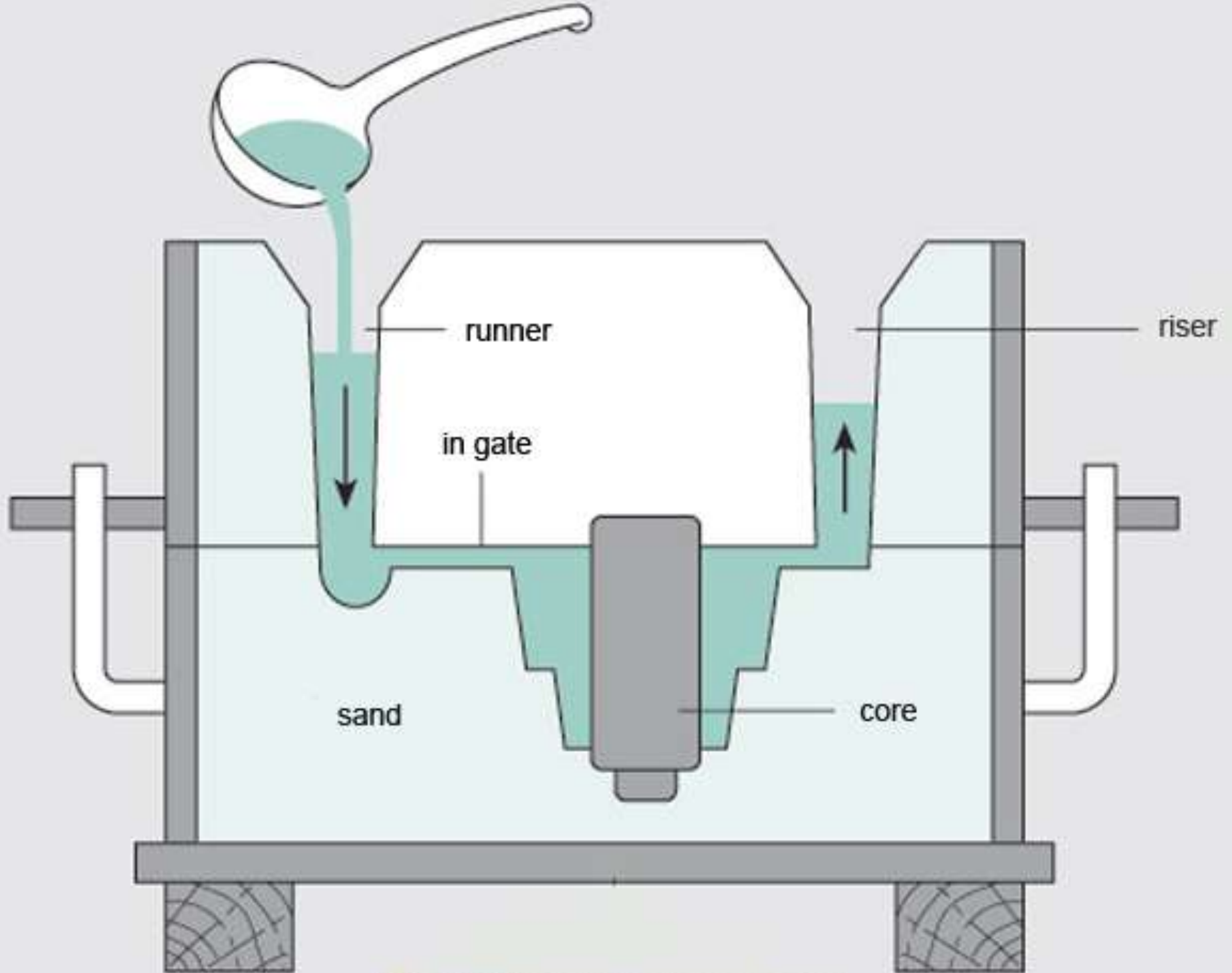

Casting process



<https://www.slideshare.net/vicky937/casting-its-types>
<https://www.slideshare.net/tayyabwarraich/7casting-ppt>
<https://www.slideshare.net/manojmama22/casting-27298833>
<http://www.themetalcasting.com/casting-process.html>

The Metal Casting Process

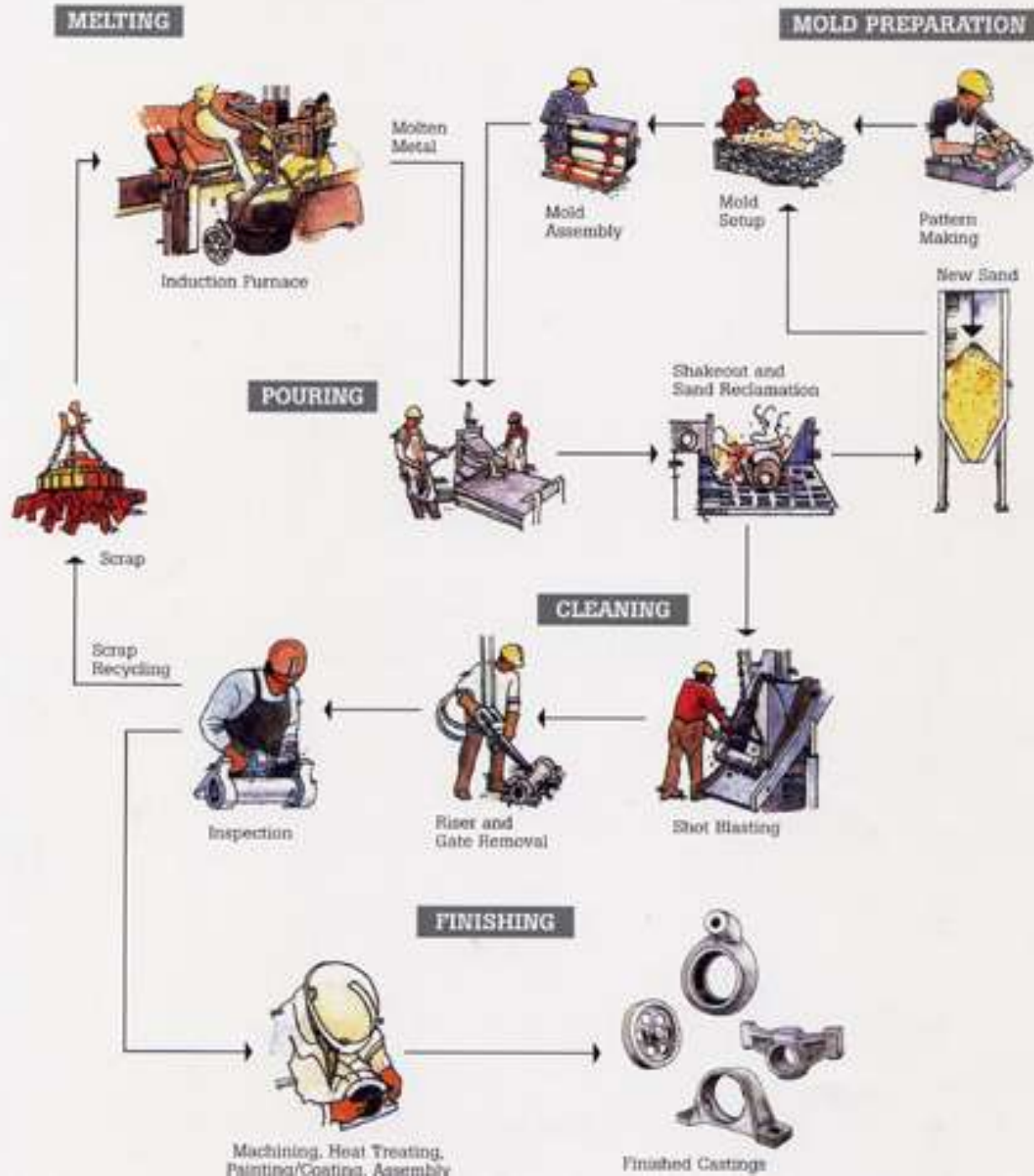

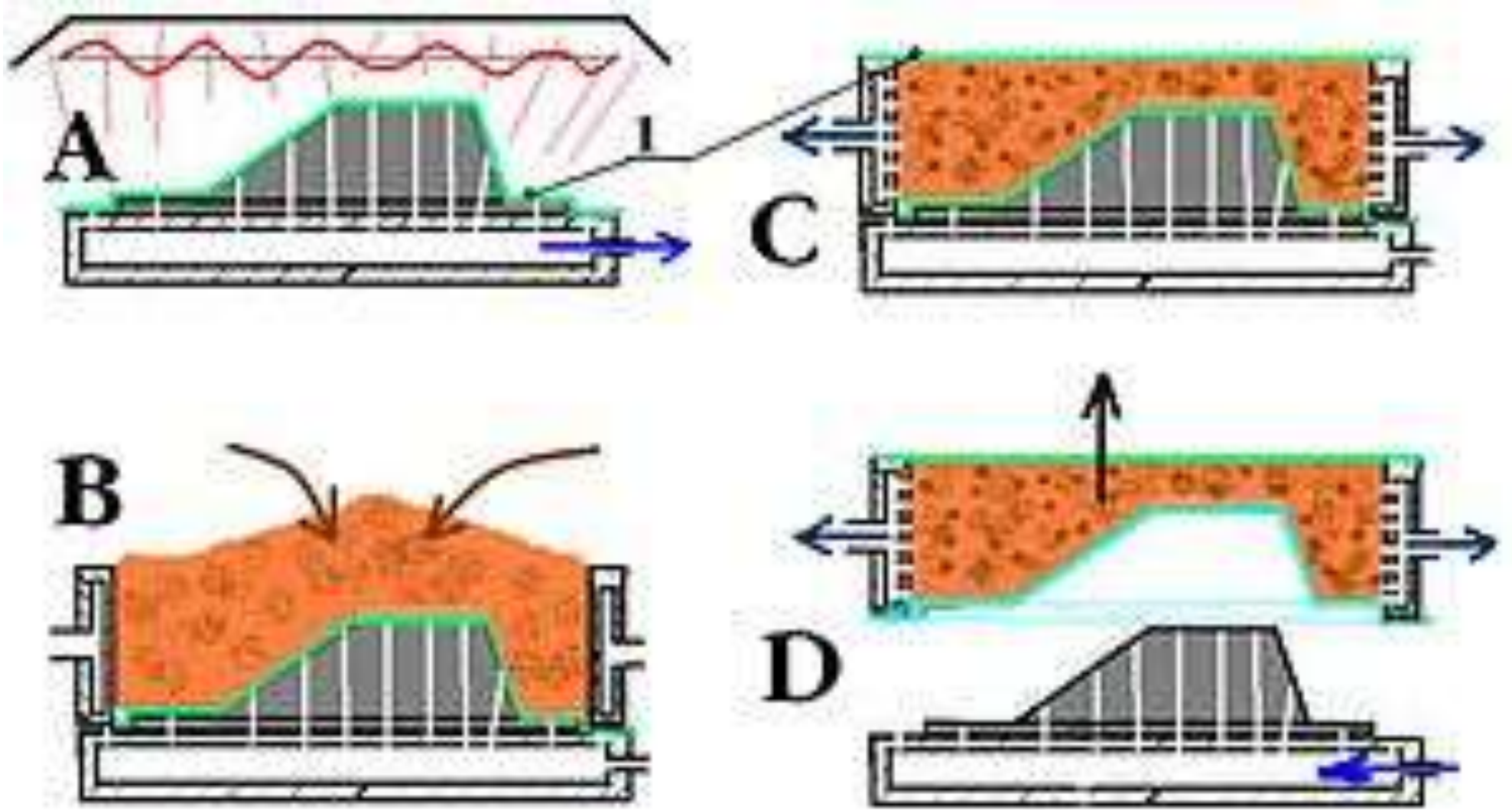

Sand Casting

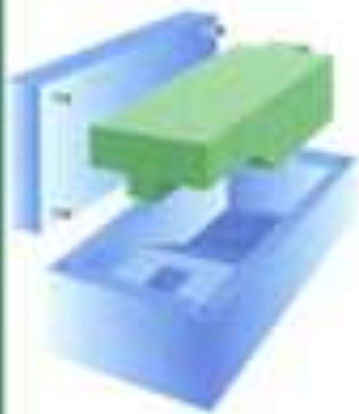

Die and pattern



Pattern assembly



Investing



Stuccoing

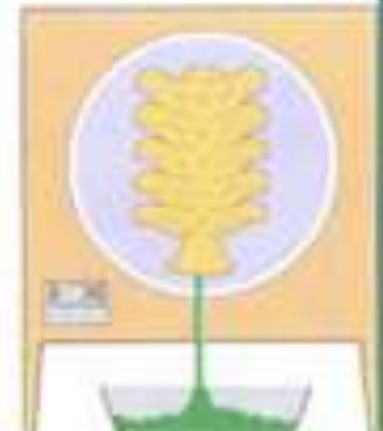

Dewaxing



Firing



Casting



Knock-out



Finishing



Inspection

The Basic Steps in the Investment Casting Process

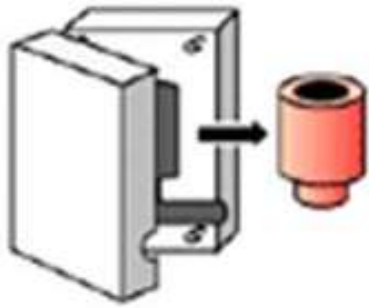

Wax Injection

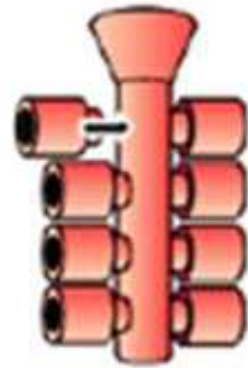

Assembly

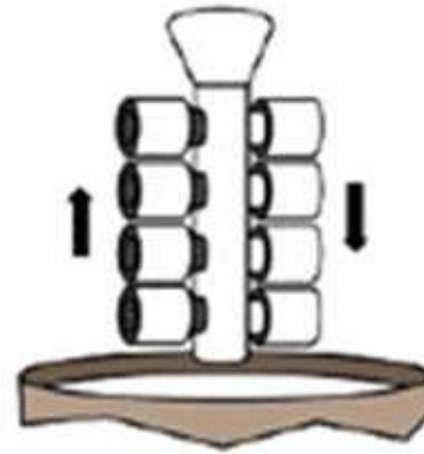

Shell Building

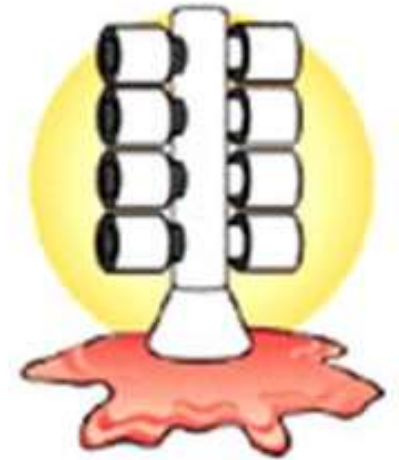

Dewax/Burnout



Gravity Pouring



Knock Out

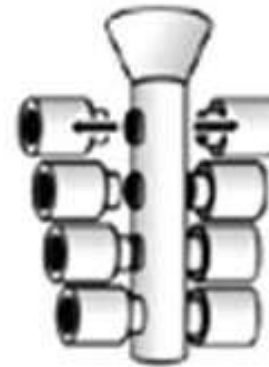

Cut-off



Finished Castings

Investment Casting

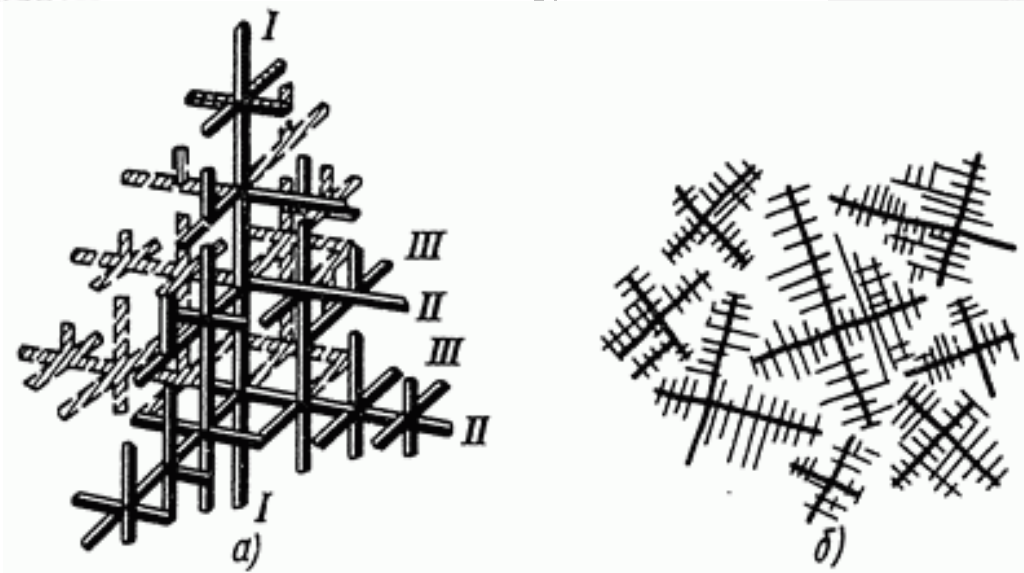
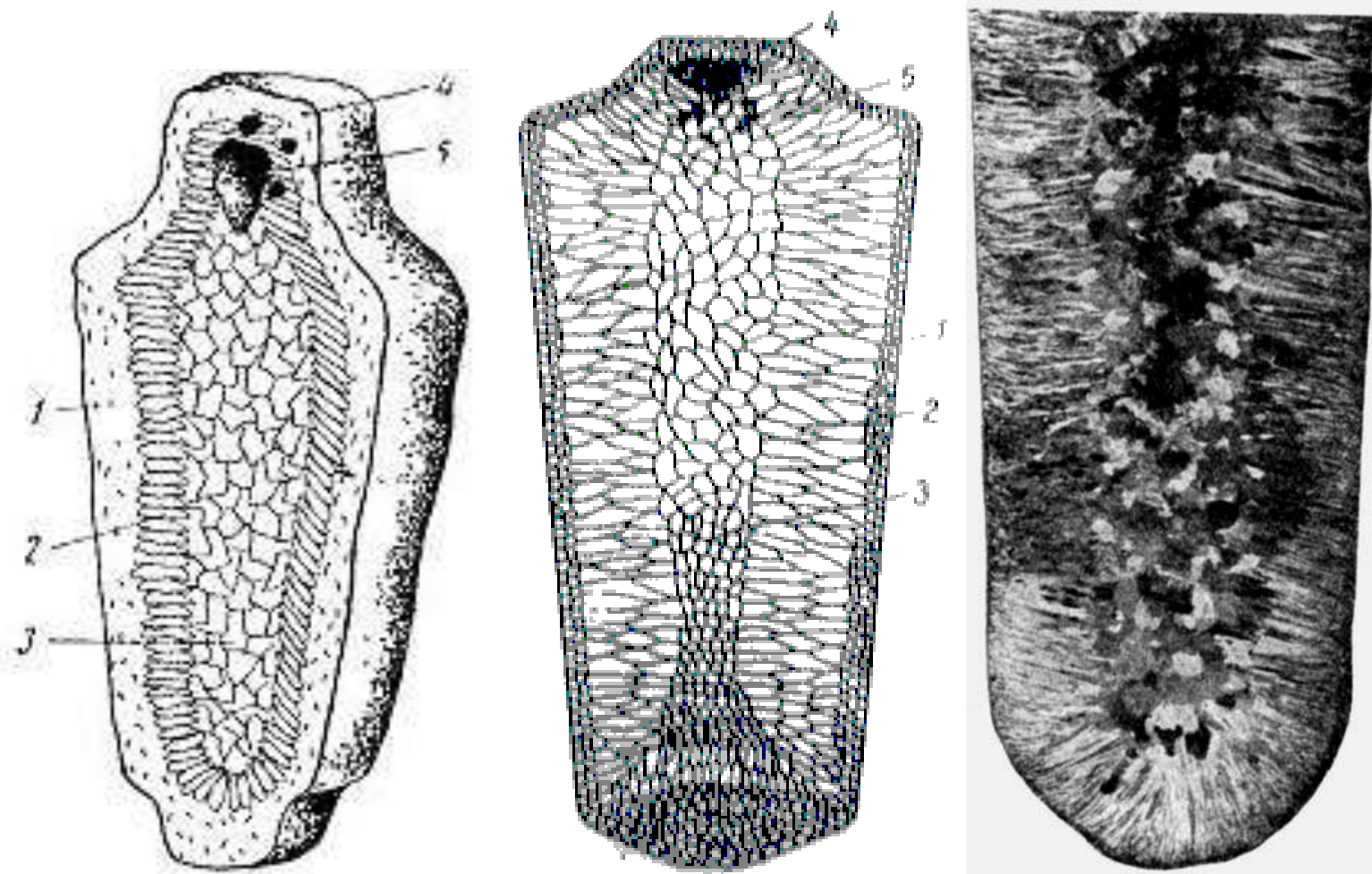

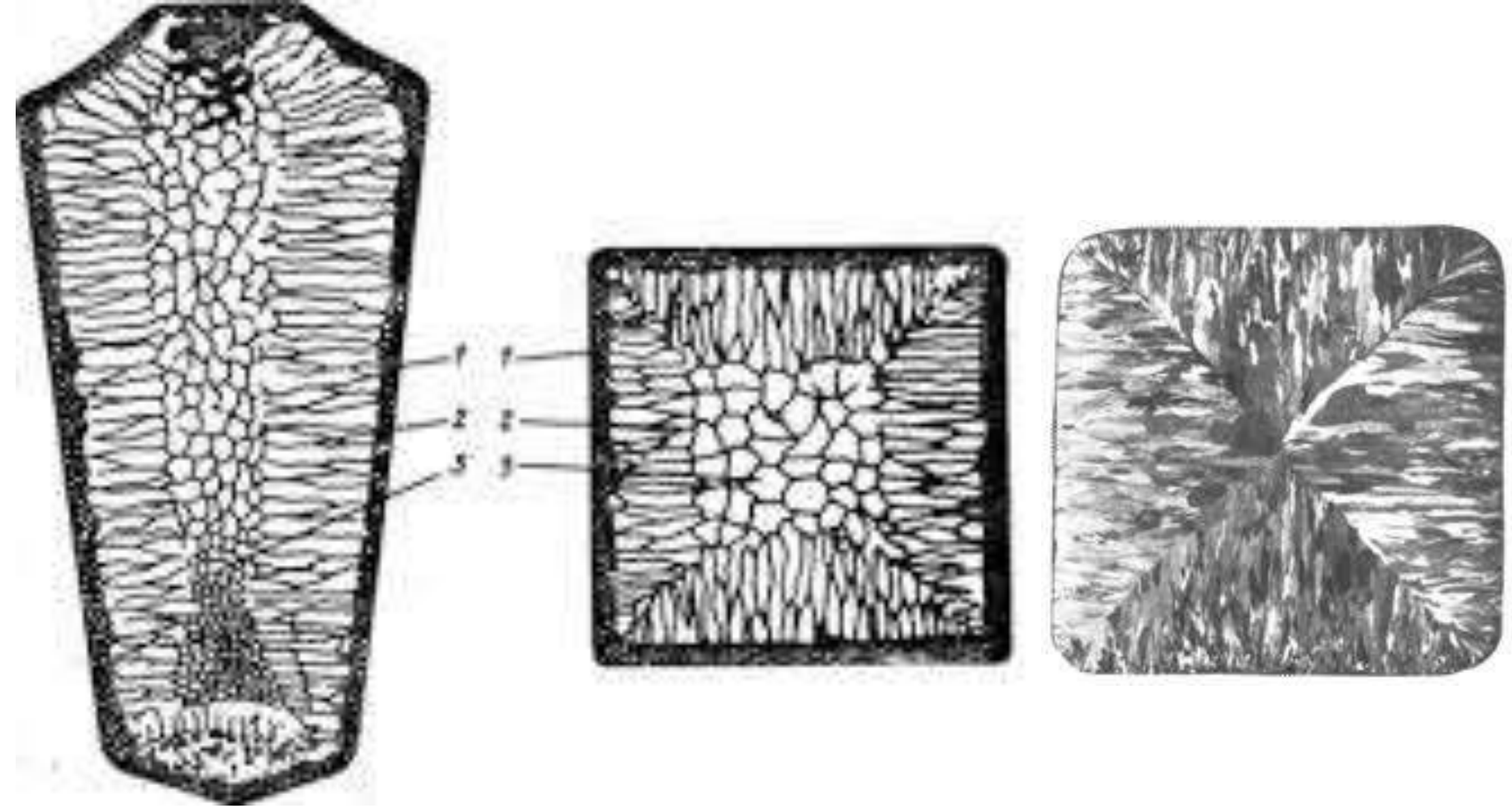

Grain Structure of Casted Ingots



Raw Materials



Melting



Casting



Sawing



Scalping



Homogenizing



Hot Rolling



Tandem Mill



Cold Rolling



Slitting



Blanking



Annealing



Packing



Inspection



Delivery

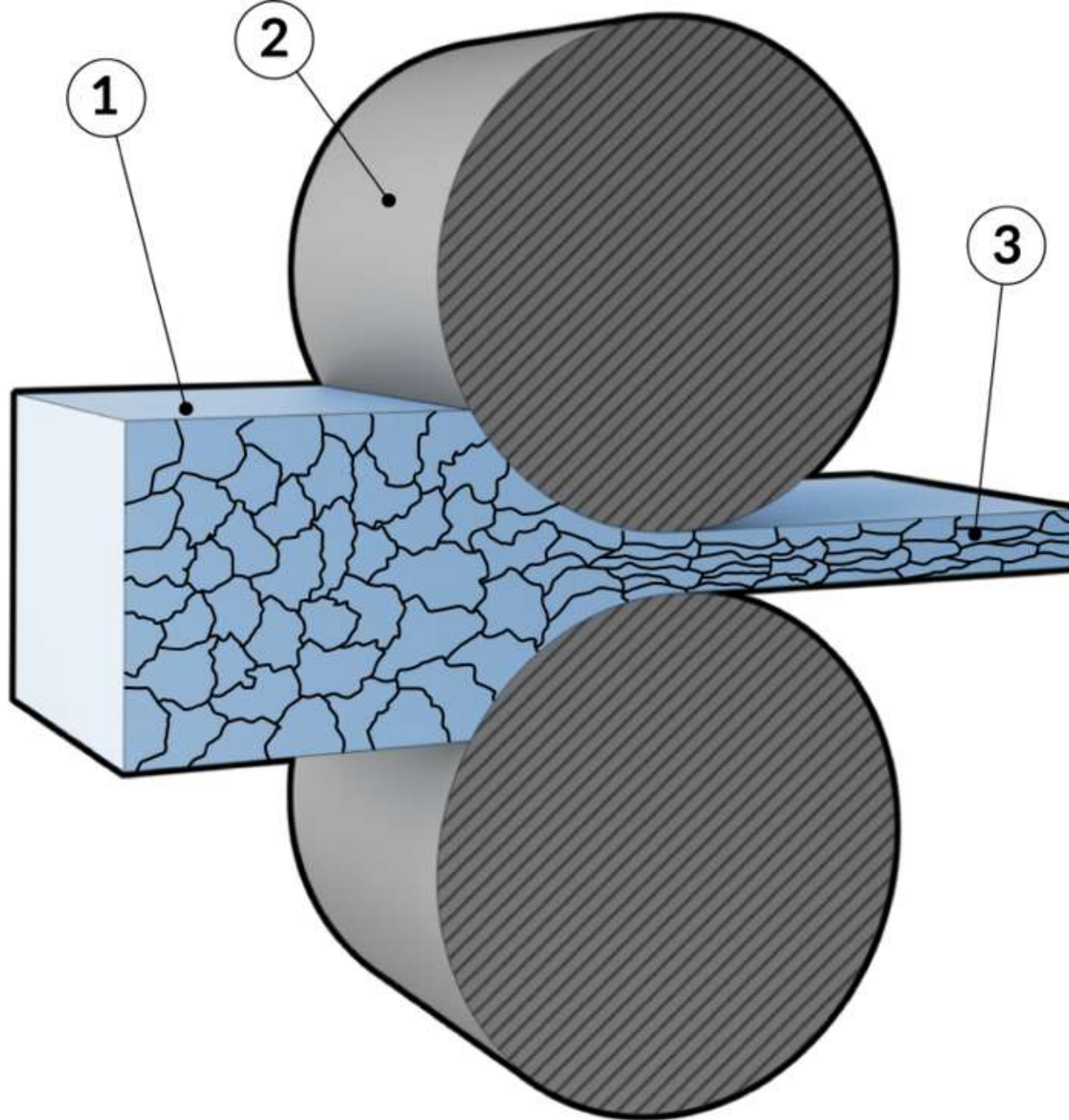

Cold rolling of sheets

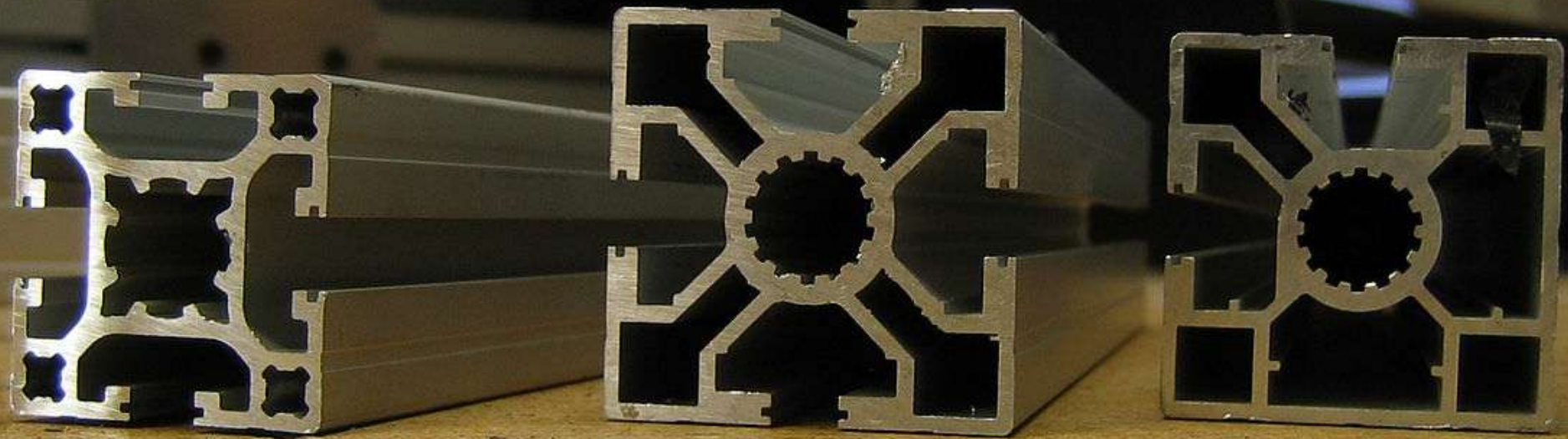

Extruded aluminium profile

Extruded aluminium with several hollow cavities; [T slots](#) allow bars to be joined with special connectors.

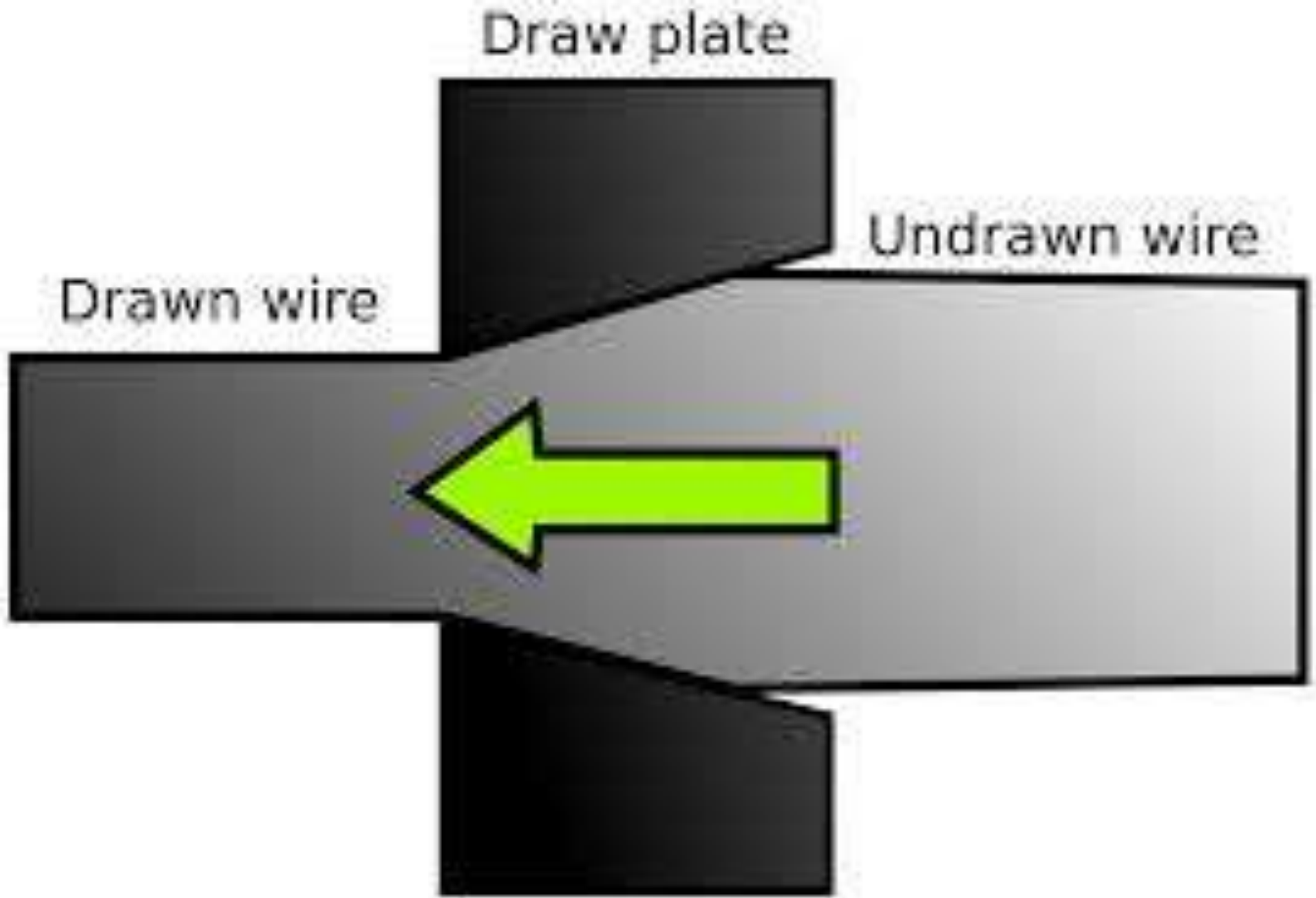

Drawing (Wire Dragging) Process

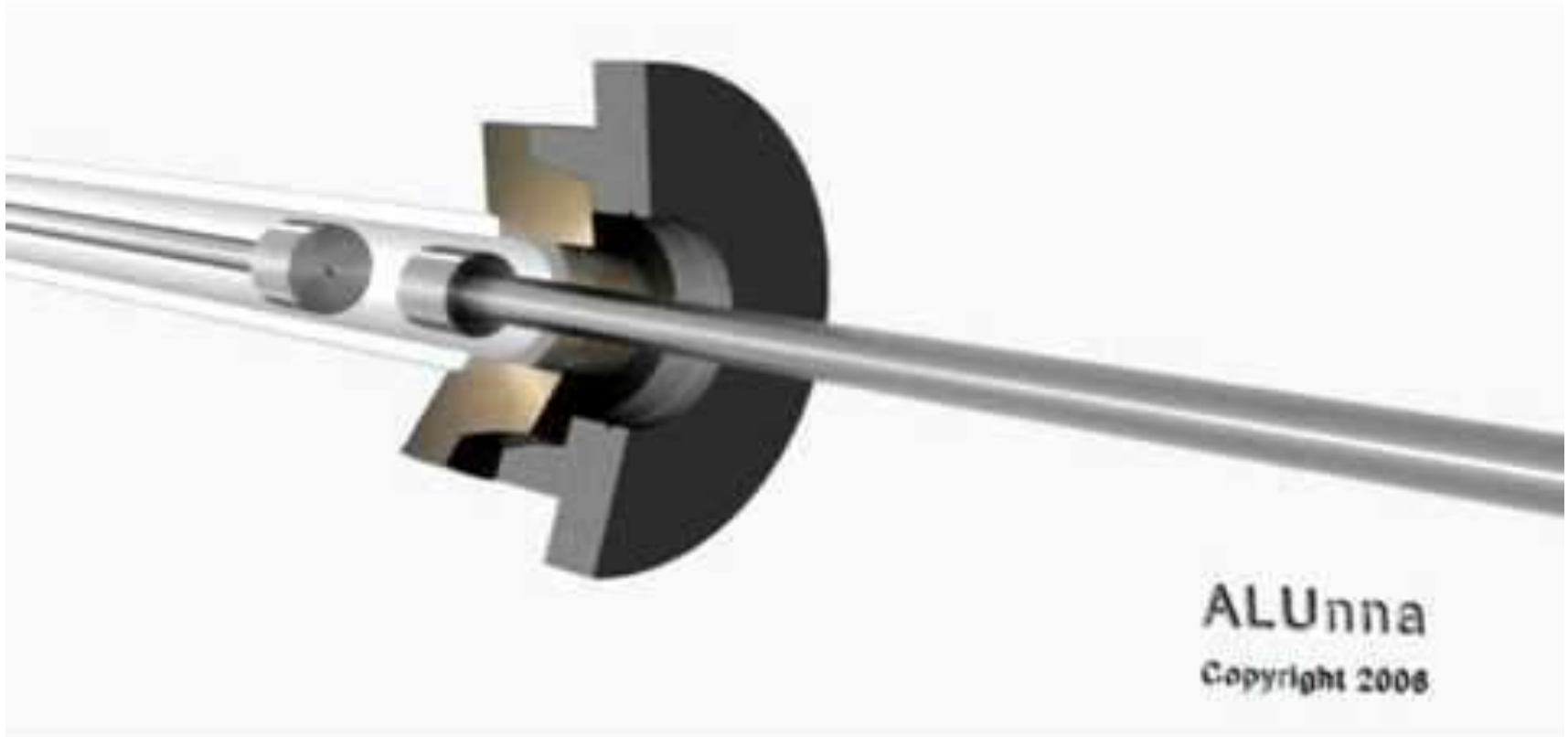

ALUnna
Copyright 2008

Wire Drawing:

Produces rods / bars from metallic or polymeric material

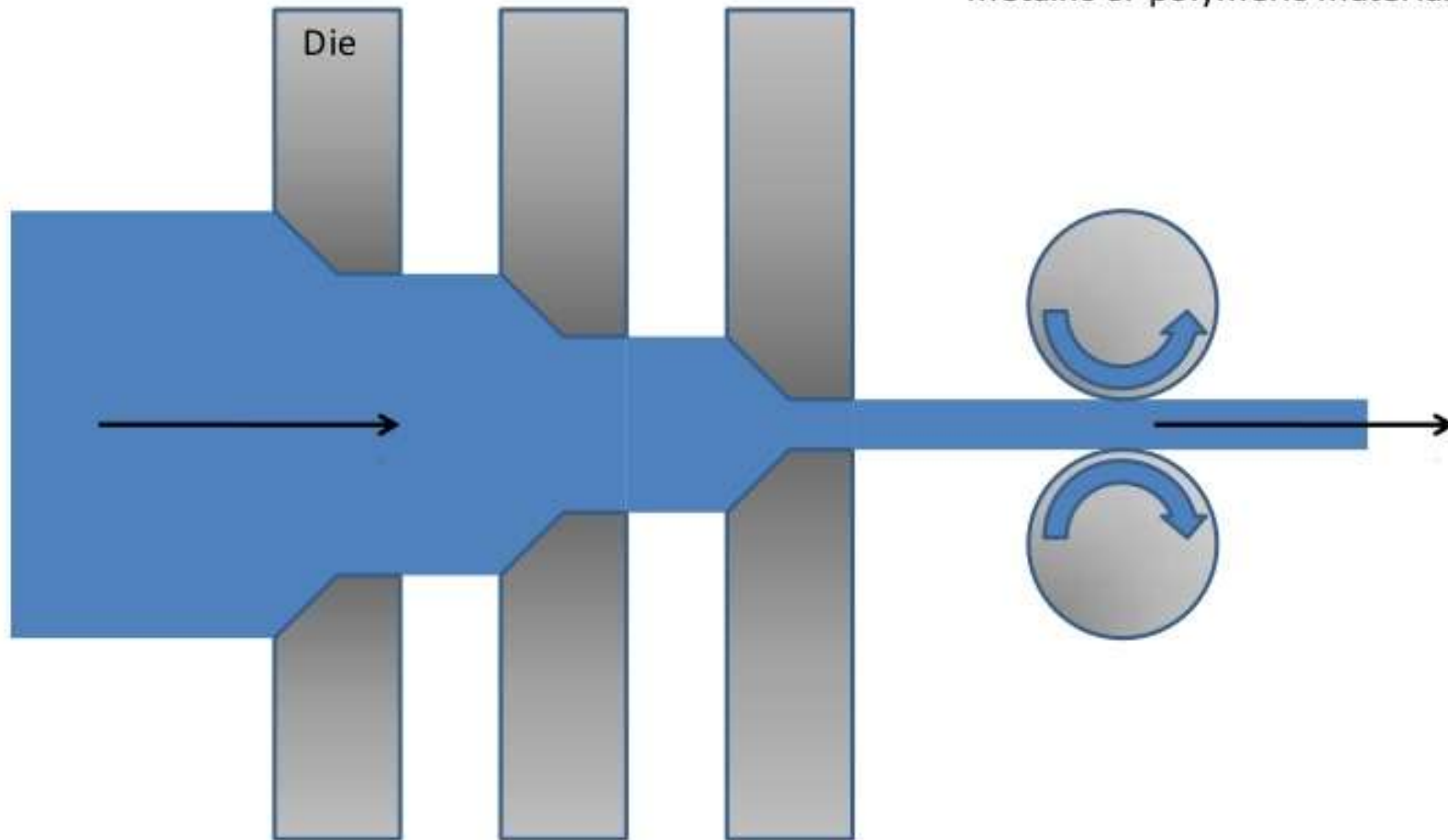



<http://www.dropforging.net/types-of-forging-processes.html>



Grain Structure of forged part

Grain flow is a directional orientation of metal grains and any inclusions that have been deformed by forging. Individual grains are elongated in the direction of the metal flow or plastic deformation.



Closed die forging dies

Upper punch



Die



workpiece

Die

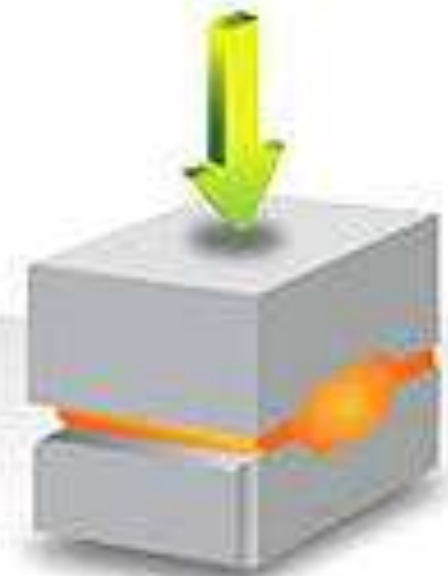
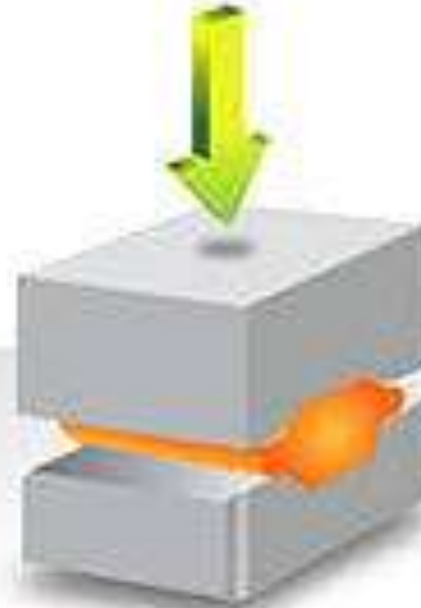



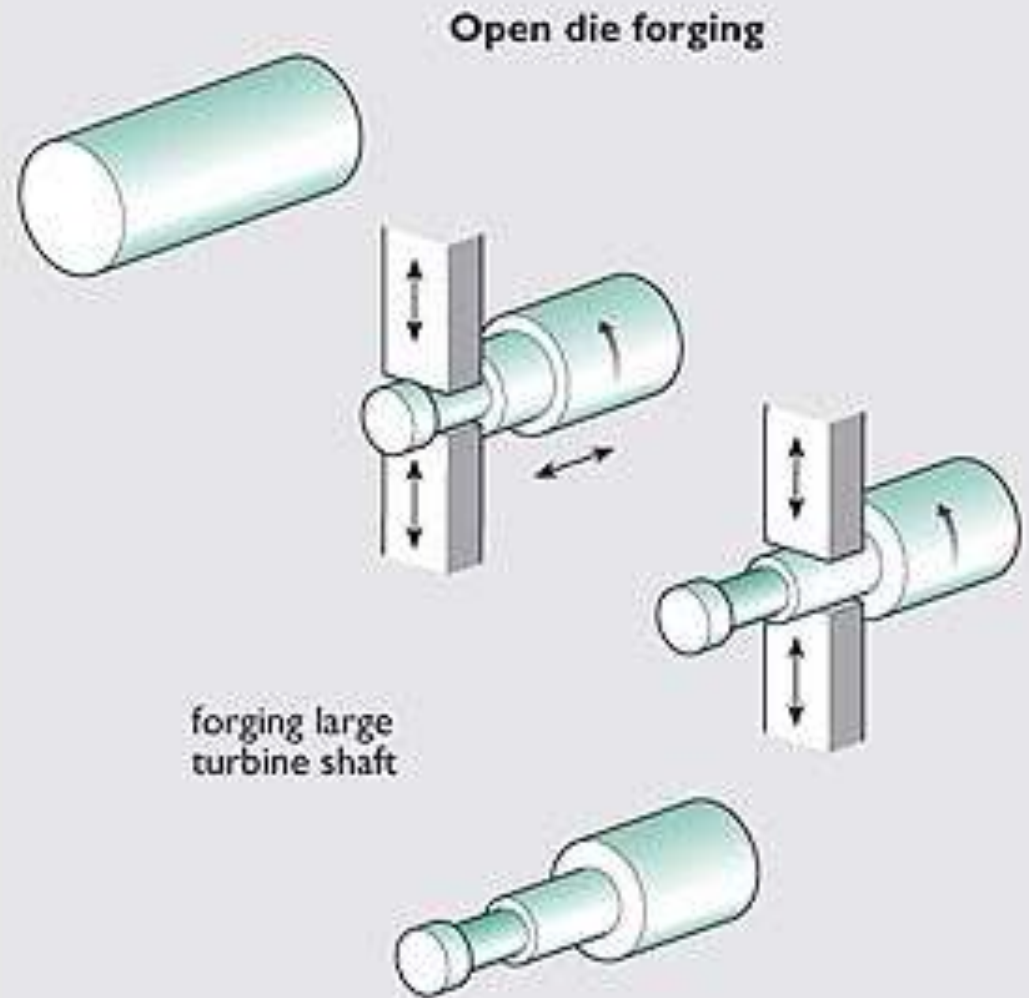
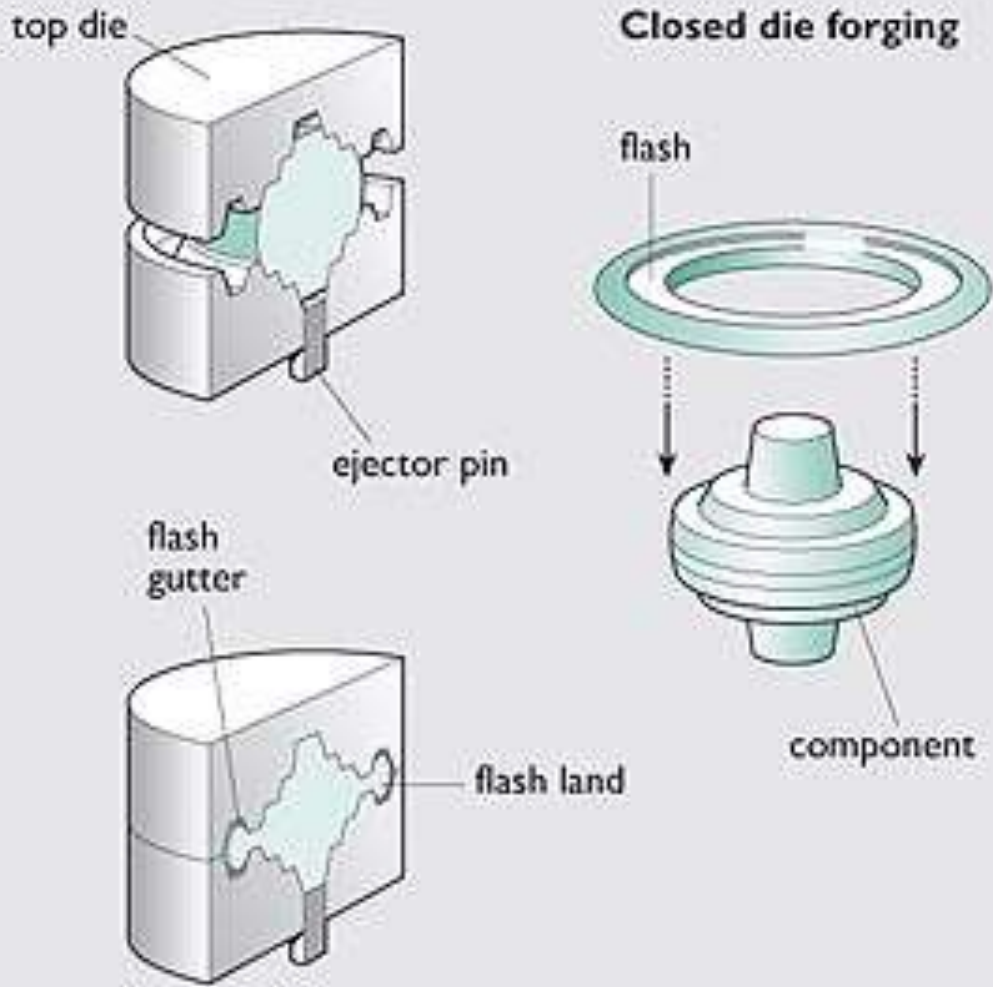







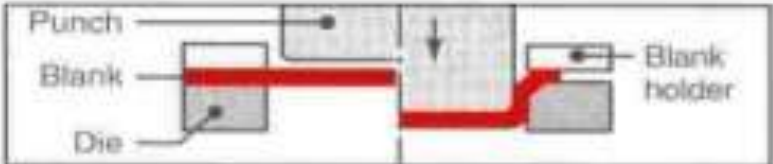







Closed die forging process

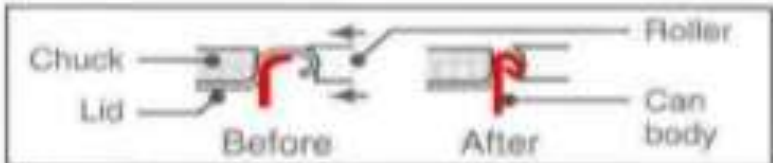

Differences between closed die forging & open die forging

<http://www.dropforging.net/image/closed%20die%20forging-5204.gif>
<https://www.forging.org/types-of-forging-processes>
<http://engineeringhut.blogspot.com/2010/10/forging-and-its-types.html>

Process	Process illustration	Result
1. Blanking	 <p>Punch Stock Die Blank</p>	 <p>Cross-section</p> 
2. Deep drawing	 <p>Punch Blank Die Blank holder</p>	 
3. Redrawing	 <p>Punch Deep-drawn cup Die Hold down</p>	 
4. Ironing	 <p>Punch Redrawn cup Die Ironing ring</p>	 
5. Doming	 <p>Punch Ironed cup Die</p>	 
6. Necking	 <p>Domed can Support Spinning tools</p>	 
7. Seaming	 <p>Chuck Lid Before After Roller Can body</p>	 

All Types Of Saws

Oscillating (Dremel™)	Jig	Reciprocating (Sawzall™)	Circular	Miter/Chop	Band	Table
						

SAW  **WIZ**
 THE MOST EFFECTIVE WEBSITE FOR YOUR NEXT SAW

SIDE-BY-SIDE SAW COMPARISON

SAW NAME	Oscillating (Dremel™)	Jig	Reciprocating (Sawzall™)	Circular	Miter/Chop	Band	Table
PIC							
PRICE RANGE	\$20-\$100	\$20-\$150	\$25-\$170	\$25-\$170	\$80-\$500	\$120-\$400	\$200-\$800

Circular Saw



Table Saw



Radial Arm Saw



Miter Saw



Rotary Saw/Roto Zip





Types of Chips

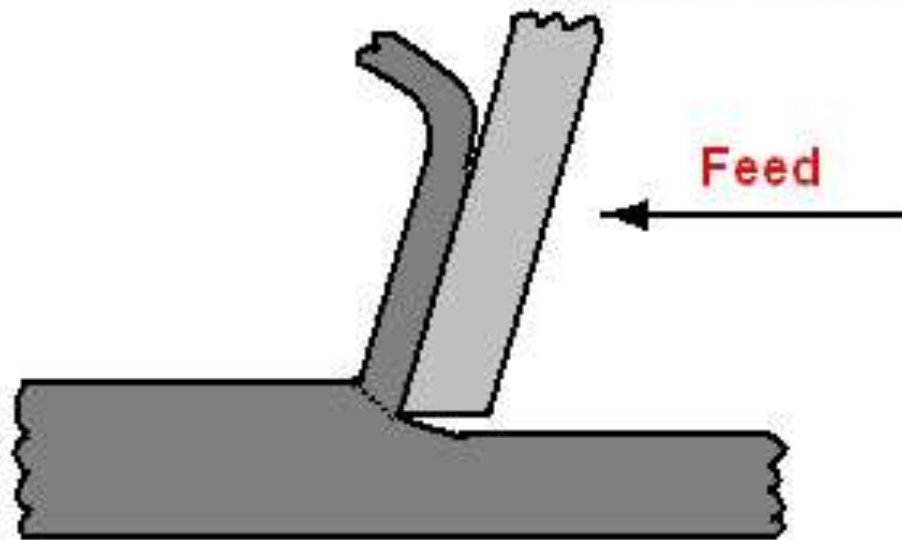

Continuous Chip

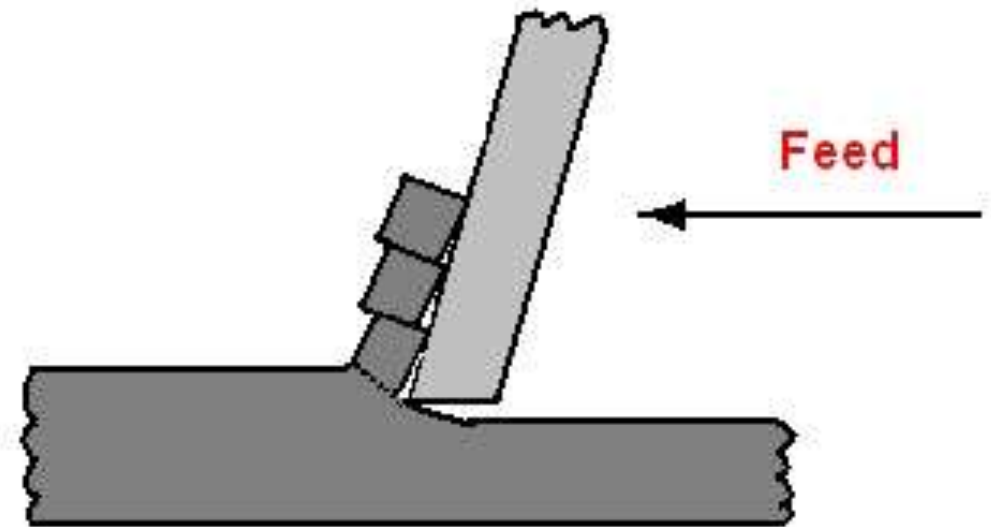

Discontinuous Chip

Built up edge on tool

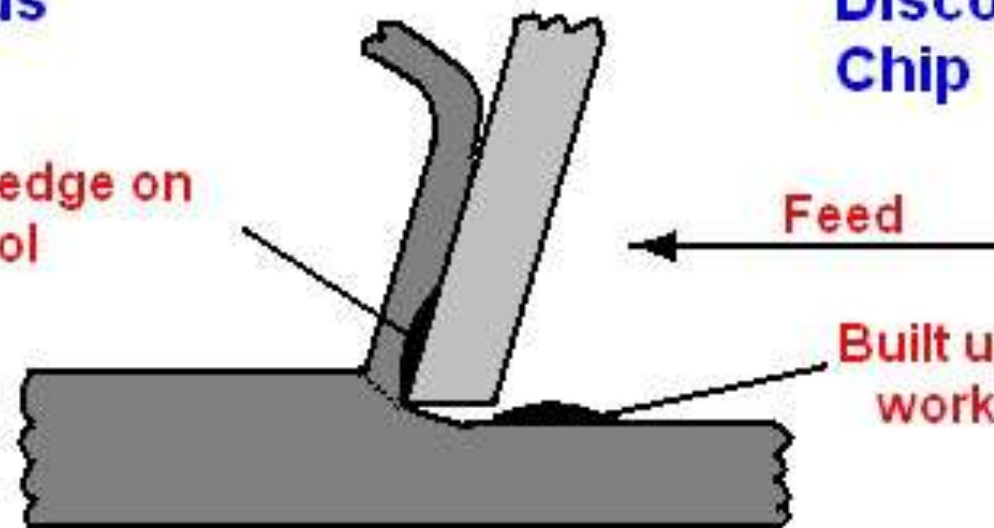

Built up edge on work piece

Built up Chip

CHIP FORMATION AND CUTTING TEMPERATURES IN DIFFERENT WORKPIECE MATERIALS

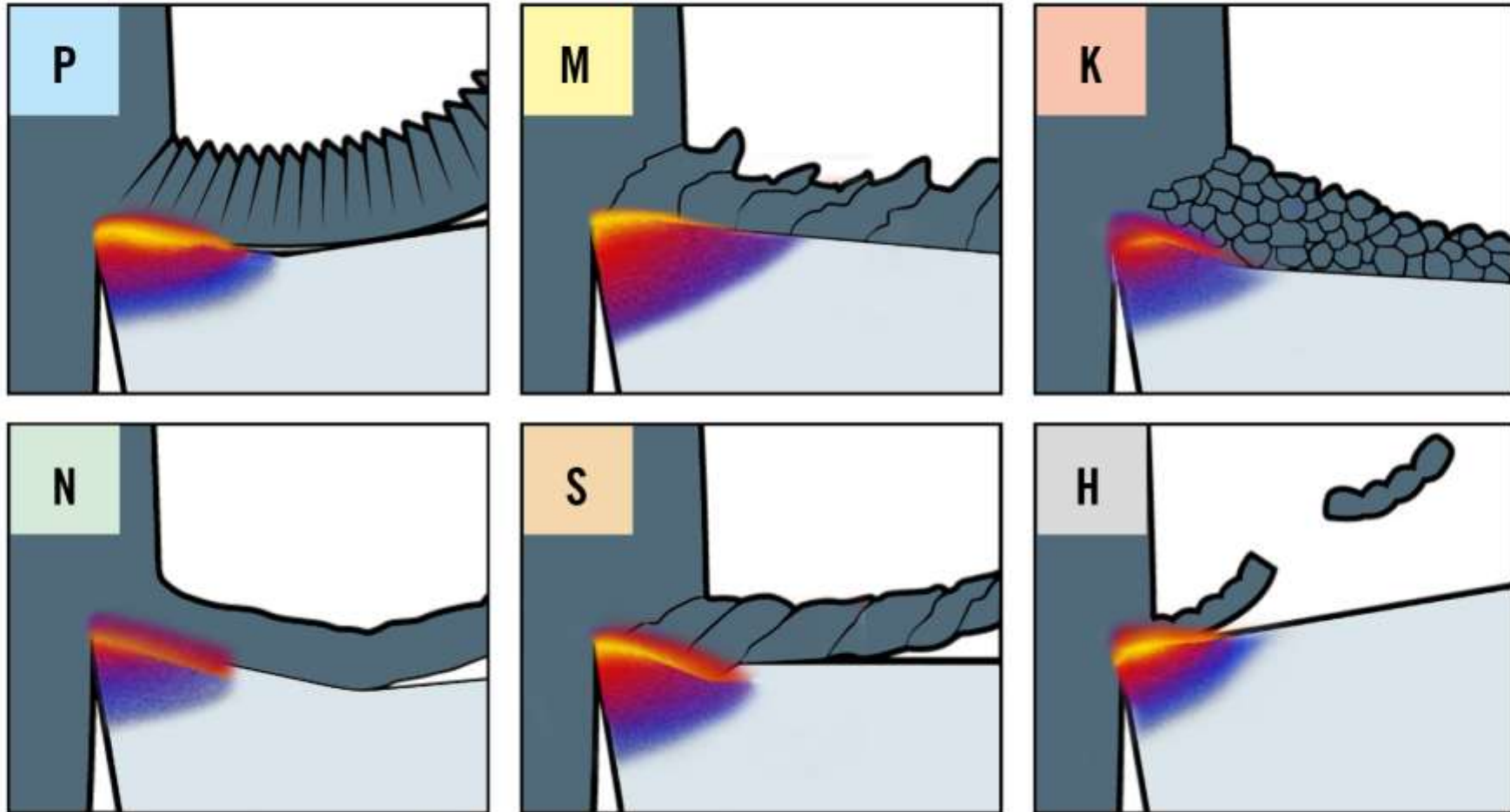

Each workpiece material type affects the chip formation process differently, everything from chip type to heat generation to cutting temperatures varies.

<https://www.slideshare.net/NamanDave/metal-cutting-1>

<http://slideplayer.com/slide/10286132/>

<https://www.slideshare.net/NamanDave/metal-cutting-2>



bwc33028197 Barewalls ©



Introduction

Single point Cutting Tool

- Removal of the metal from the workpiece by means of cutting tools which have one major cutting edge.

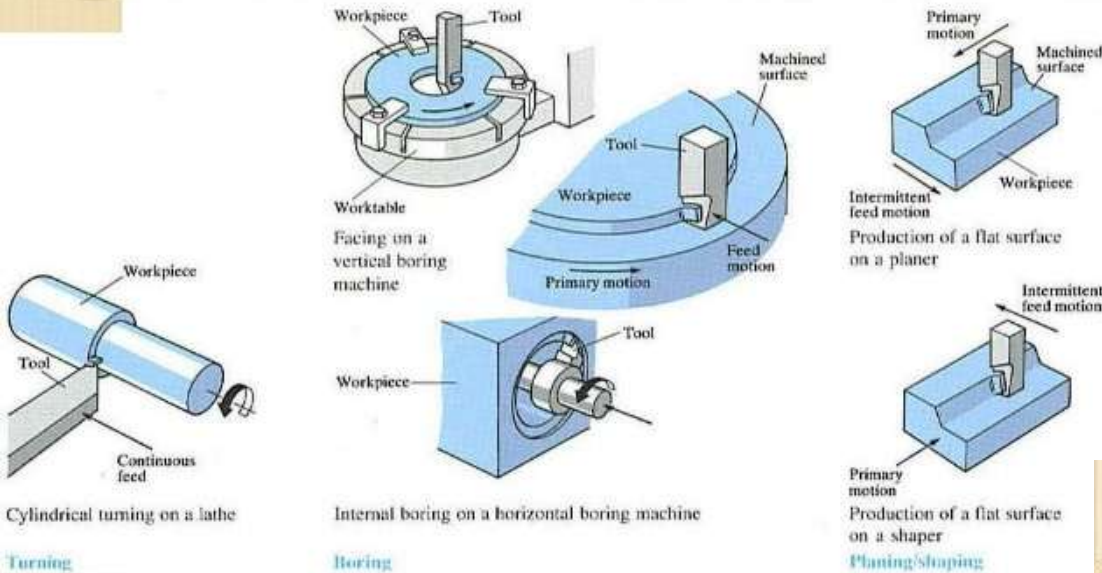

Introduction

Multi-point Cutting Tool

- Removal of the metal from the workpiece by means of cutting tools which have more than one major cutting edge.

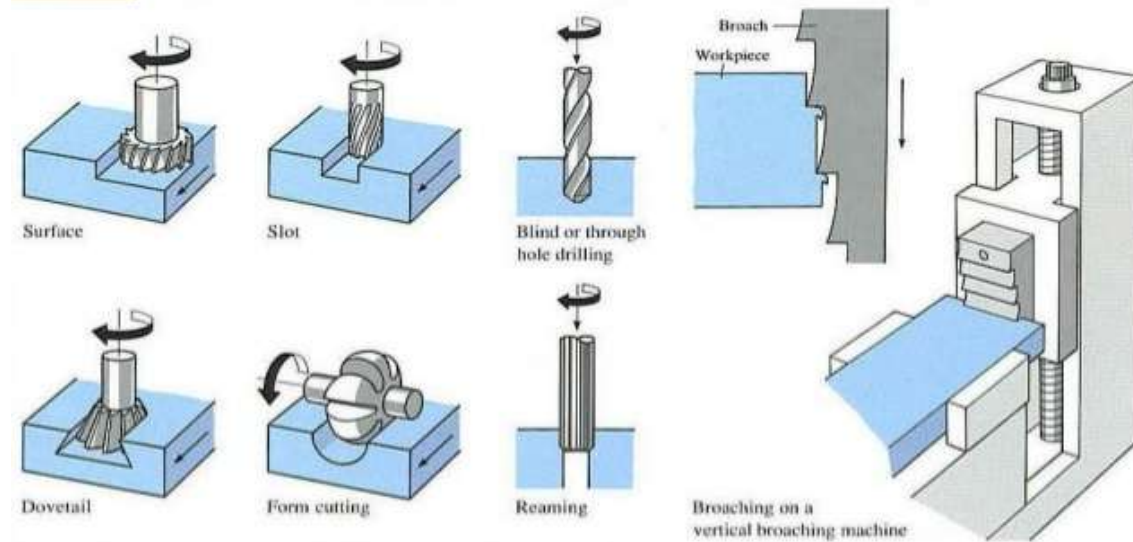

TYPES OF EDM

○ Wire Machining

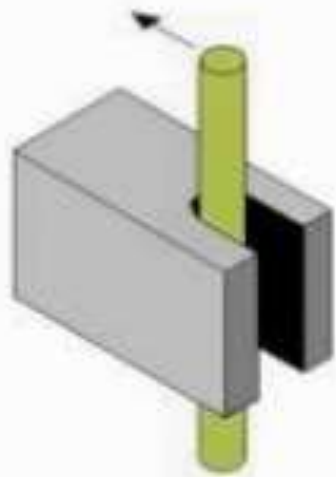

○ Ram Machining

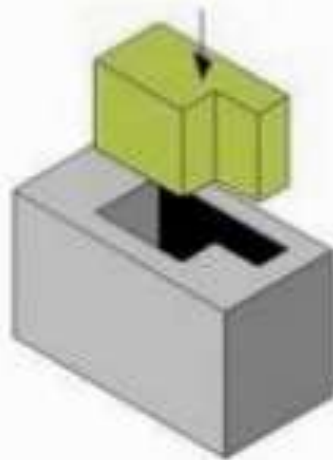

Other EDM Processes

Electrical Discharge Milling

Electrical Discharge Grinding

Electrical Discharge Dressing

Ultrasonic Aided EDM

Abrasive Electrical Discharge Grinding

Micro Electrical Discharge Machining

Micro Wire EDM

Mole EDM

Double Rotating Electrodes EDM

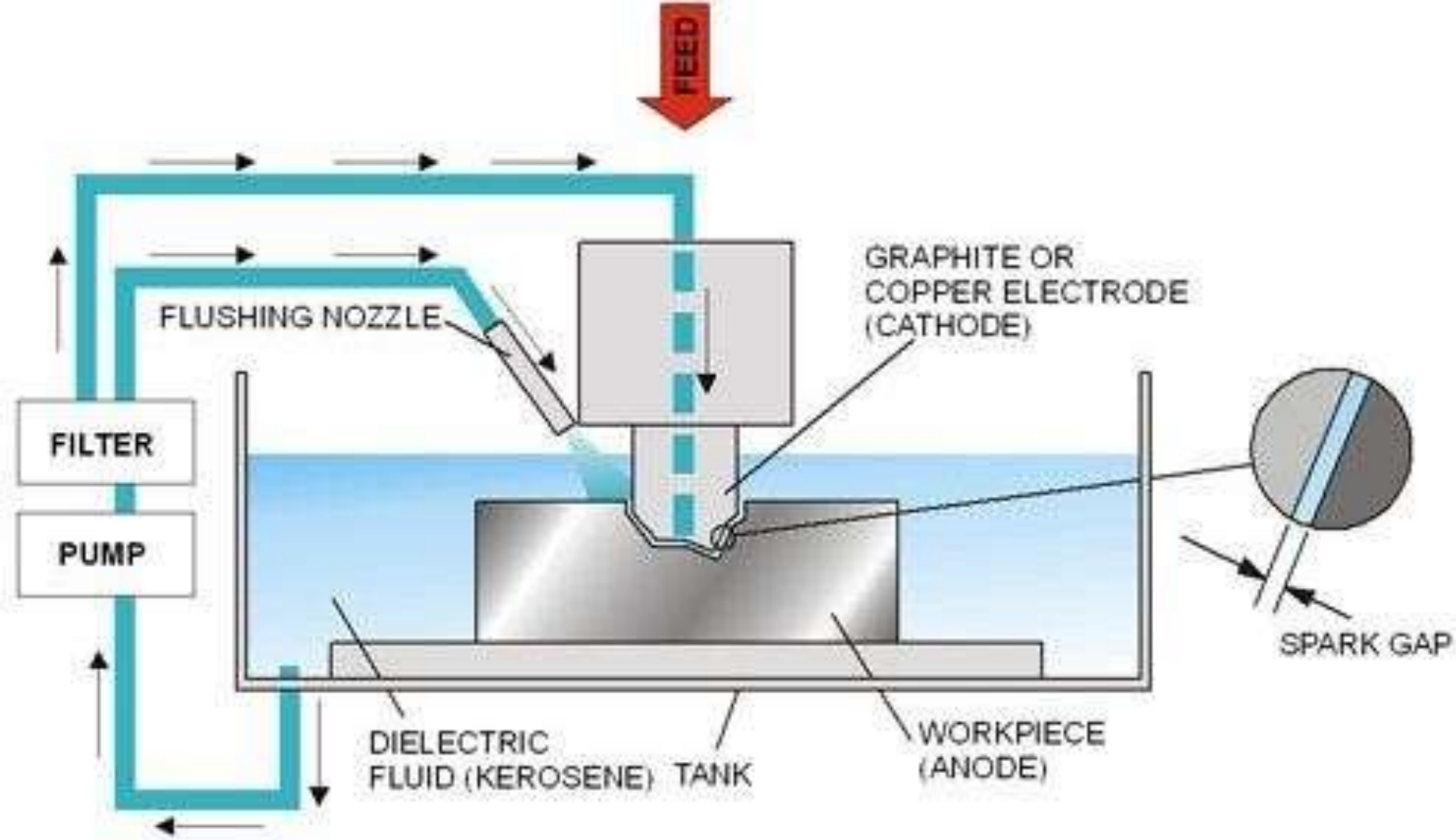

ELECTRIC DISCHARGE MACHINING

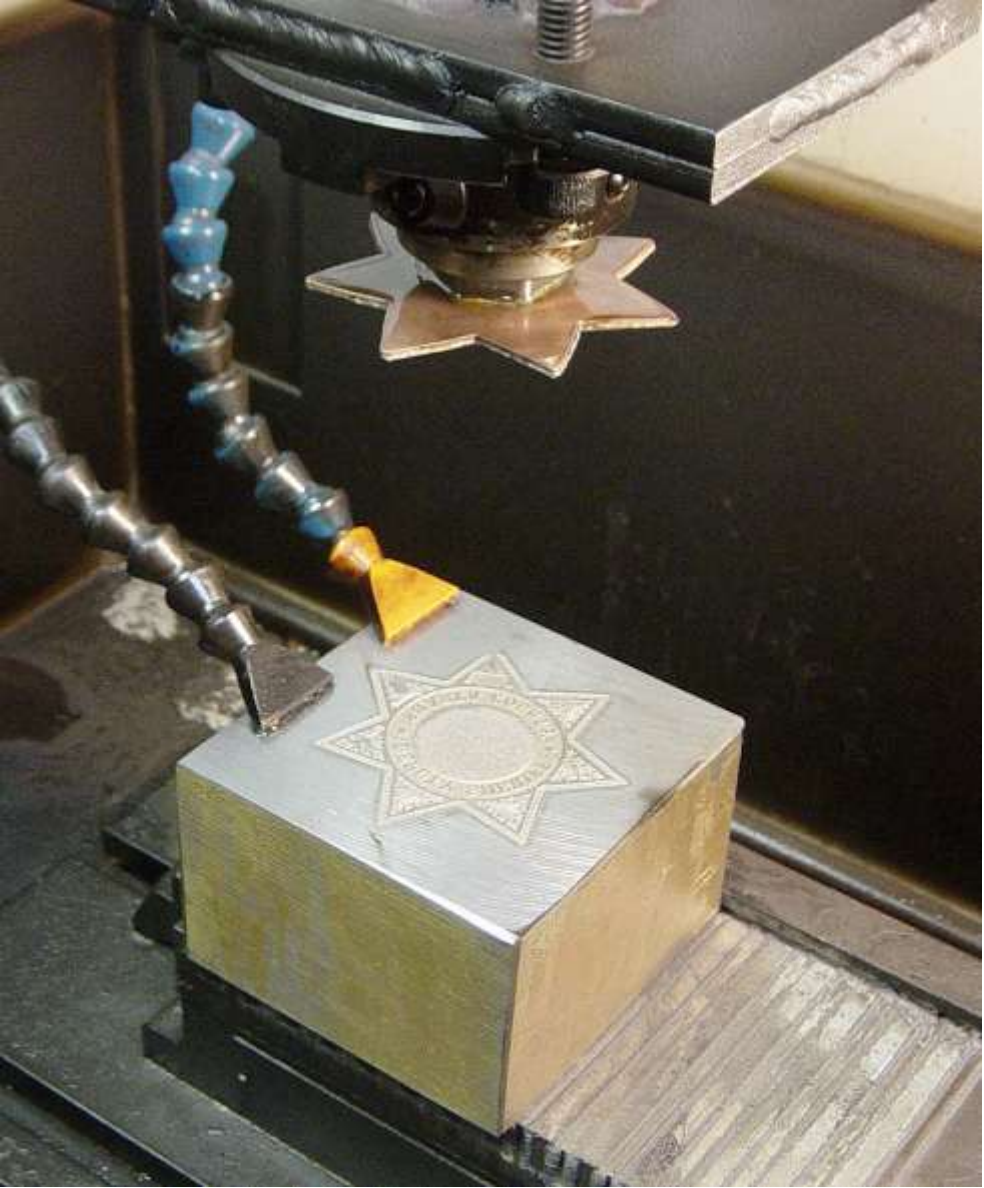



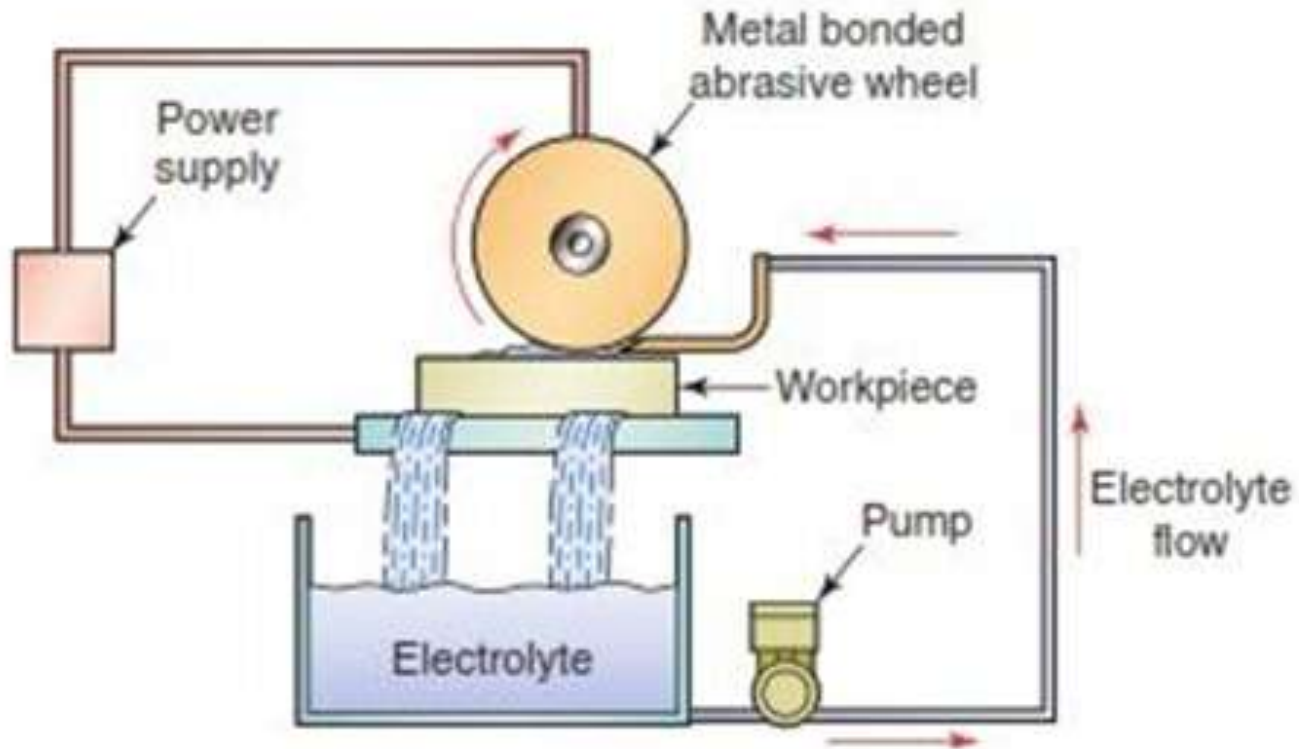

WORKING OF ECG

Electro Chemical Grinding



Sheet Metal Laser Cutting



CNC Plasma Cutting



Ultrasonic Cutting Conveyors



Ultrasonic Cutting

